

CARSON

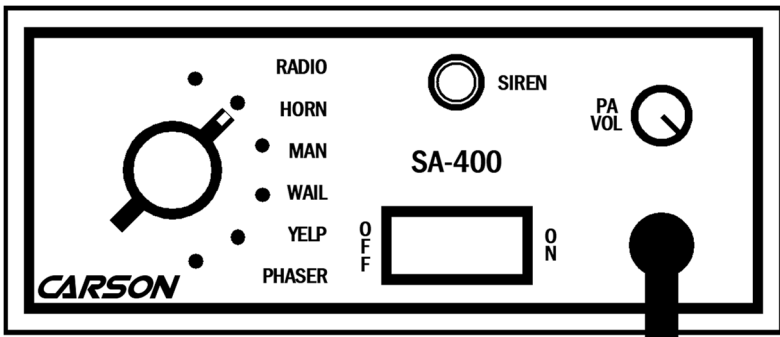

Carson Manufacturing Co., Inc.
5451 North Rural Street
Indianapolis, IN 46220
Phone: (888) 577-6877 Fax: (317) 254-2667
www.carsonsirens.com

SA-400-10 SIREN AMPLIFIER



INSTALLATION AND OPERATING INSTRUCTIONS

Carson is a trademark of Carson Manufacturing Company, Inc.

WARNING   **Sound Hazard** - Sound level from siren speaker (>120dBA @ 10 feet) may cause hearing damage. Do not operate siren without adequate hearing protection for you and anyone in immediate vicinity. (Ref. OSHA 1910.95 for occupational noise exposure guidelines)

INSTALLATION INFORMATION	
MODEL: SA-400- _____	OPTIONS
SERIAL NO: _____	_____ Two-Tone enabled
PURCHASE DATE: _____	_____ Phaser disabled
DEALER: _____	_____ Horn disabled
INSTALL DATE: _____	_____ HRC2 enabled
INSTALLER: _____	_____ Short Manual enabled
_____	_____ Radio Input connected
_____	_____ Auxiliary connection/polarity
Model and serial number located on bottom of unit	

TABLE OF CONTENTS

GENERAL DESCRIPTION	3
SPECIFICATIONS	3
INSTALLATION	3
SAFETY PRECAUTIONS	3
UNPACKING	4
MOUNTING	4
OPTION SWITCHES	4
ELECTRICAL CONNECTIONS	5
OPERATION	6
GENERAL	6
SELECTOR SWITCH	6
SIREN SWITCH	6
MICROPHONE	6
PA VOL	6
AUXILIARY INPUT	6
RADIO VOLUME	6
HORN RING CYCLER 2 (Optional)	6
SERVICE	7
PROBLEMS	7
PARTS	7
RETURN	8
LIMITED WARRANTY	8

NOTICE

Due to continuous product improvements, we must reserve the right to change any specifications and information, contained in this manual at any time without notice.

Carson Manufacturing Co., Inc. makes no warranty of any kind with regard to this manual, including, but not limited to, the implied warranties of merchantability and fitness for a particular purpose.

Carson Manufacturing Co., Inc. shall not be liable for errors contained herein or for incidental or consequential damages in connection with the furnishing, performance, or use of this manual.

	<p>WARNING Sound Hazard - Sound level from siren speaker (>120dBA @ 10 feet) may cause hearing damage. Do not operate siren without adequate hearing protection for you and anyone in immediate vicinity. (Ref. OSHA 1910.95 for occupational noise exposure guidelines)</p>
--	--

GENERAL DESCRIPTION

The SA400 Siren Amplifier is a premium unit designed for single or dual 100W speaker use. A 6-position rotary switch controls the primary operating modes of Phaser, Yelp, Wail, Manual, Horn and Radio. A Siren control button is provided for control of the output tone when in the Manual mode, and control of Horn, Power C and Yelp Overrides, depending on the function switch setting. An independent rocker switch controls power. A permanently mounted noise canceling PA microphone with front panel volume control overrides all modes except Radio. An internal control is used to adjust Radio volume. An auxiliary input is provided for connection to a positive or negative horn ring circuit or switch, performing the same function as the Siren button. An internal 8-position DIP switch allows selection of various options. The front panel is backlit with LED's for night visibility. This durable unit utilizes short circuit, high voltage, and reverse polarity protection systems for maximum service life over a wide temperature range.

SPECIFICATIONS

Input Voltage	9 - 16 VDC (negative ground)					
Input Current	8 AMPS (@14 VDC - single 100W speaker) 16 AMPS (@14 VDC - dual 100W speakers)					
Standby Current	Less than 150 mA					
Audio Frequency	200Hz - 10 kHz \pm 3db					
Audio Distortion	Less than 3% (@1 kHz - single 100W speaker)					
Audio Output	40 watts (@14 VDC - single 100W speaker)					
Audio Input	400 ohms \pm 10%					
Output Power	105 WATTS RMS MAX. (15 VDC - single 100W speaker) 180 WATTS RMS MAX. (15 VDC - dual 100W speakers)					
Siren Frequency	700Hz - 1500Hz (Two-Tone and Horn = 435 & 585Hz)					
Tones / Cycle Rates	Horn 109 CPS	Wail 13 CPM	Power C 100 CPM	Yelp 190 CPM	Phaser 15 CPS	Two-Tone 60 CPM
High Voltage Protection	16 - 18 VDC will cause siren output to cease, resume at normal					
Short Circuit Current	50 AMPS (supply circuit must be capable of supplying this)					
Operating Temperature	-15° F to +140°F					
Controls	6-position rotary mode switch (Phaser, Yelp, Wail, Manual, Horn and Radio). Momentary push-button Siren switch. Front panel mounted PA volume control, internal Radio adjust Auxiliary input for positive or negative connection. Internal 8-position DIP switch option selector.					
Connections (9-Pin Conn)	(2) Positive, (2) Negative, (2) Speaker, (2) Radio, Auxiliary					
Size	6-1/8" Wide, 5-3/8" Deep, 2-1/2" High					
Weight	5-1/2 LBS.					

INSTALLATION

Proper installation of the unit is essential for years of safe, reliable operation. Please read all instruction **before** installing the unit. Failure to follow these instructions can cause serious damage to the unit or vehicle and may void warranties.

SAFETY PRECAUTIONS

For the safety of the installer, vehicle operator, passengers and the community please observe the following safety precautions. **Failure to follow all safety precautions and instructions may result in property damage, injury or death.**

Qualifications - The installer must have a firm knowledge of basic electricity, vehicle electrical systems and emergency equipment.

Mounting - Mount the unit for easy access by the vehicle operator. DO NOT mount in air bag deployment area. Assure clearances before drilling in vehicle. To prevent internal damage mounting bolts must not enter case more than 1/4".

Wiring - Use wiring capable of handling the current required. Make sure all connections are tight. Route wiring to prevent wear, overheating and interference with air bag deployment. Install and check all wiring before connection to vehicle battery.

Testing - Test all siren functions after installation to assure proper operation. Test vehicle operation to assure no damage to vehicle.

Keep These Instructions - Keep these instructions in the vehicle or other safe place for future reference. Advise the vehicle operator of the location.

UNPACKING

Inspect contents for shipping damage. If found **alert carrier immediately**. Contents should include unit with attached microphone, wiring harness, mounting bracket, microphone bracket with 2 screws, 2 mounting bolts and these instructions. Contact supplier immediately if any components are missing.

MOUNTING

The mounting bracket supplied can be installed above or below the unit. Choose a mounting location convenient to the operator and away from any air bag deployment areas. Inspect behind mounting area for clearance. Assure adequate ventilation to prevent overheating. Consider wire routing and access to connections, as well as microphone bracket placement. Install mounting bracket to vehicle using 1/4" hardware (not supplied).

If mounting in a rack or console, make sure that mounting bolts do not enter case more than 1/4".

OPTION SWITCHES

Various options can be controlled by turning on or off any of 8 DIP switches internally mounted on the right side of the PC board.

Cover Removal - The cover is held in place by a snap-fastener on the back of the unit. While holding the case on the sides press hard with your fingers on the back of the unit. The chassis will slide out the front.

Two-Tone - Two-Tone can replace Phaser by turning on the switch labeled "T-T".

Phaser Disable - The Phaser function can be completely disabled by turning on the switch labeled "P_I".

Horn Disable - The Horn function can be disabled by turning on the switch labeled "H_I".

Horn Ring Cycler 2 (HRC2) - This option allows selection of Wail, Yelp, and Phaser by repeatedly tapping the Siren button, horn ring or other switch connected to the AUX input. Tapping the horn ring twice quickly stops tones. Holding the horn ring produces Horn. Turn on switch "HRC". See OPERATION section for further details.

Short Manual - The Manual function can be set to immediately cut off when the Siren button is released. This is selected by turning on the switch labeled "SM".

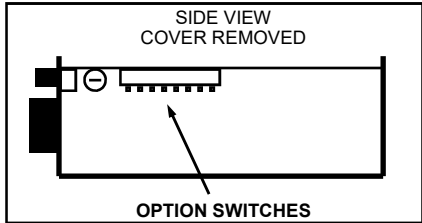

NOTE: Earlier models with S/N lower than 04190000 have a 5 position DIP switch and only offer the traditional auxiliary input.

Traditional Auxiliary Input - The auxiliary input is activated with positive (+VDC) **AND** negative (-VDC). A normally open horn ring circuit or switch is required for proper operation. If a normally open circuit is not used the auxiliary input will constantly be activated. If this is the case, a diode must be placed in series with auxiliary input to block the normally off state. Set switch "AUX_1" on and "AUX_2" off for this type of auxiliary input.

Polarity Selectable Auxiliary Input - The auxiliary input may be activated with positive (+VDC) **OR** negative (-VDC). Set switch "AUX_1" off and "AUX_2" on for this type of auxiliary input.

Auxiliary Input Polarity - Switch "AUX_P" set on for positive (+VDC) activation or set off for negative (-VDC) activation. Also "AUX_1" off and "AUX_2" on.

Activation	AUX_1	AUX_2	AUX_P
Positive and Negative Activation (Traditional Auxiliary)	ON	OFF	OFF
Positive Only Activation (Factory Default)	OFF	ON	ON
Negative Only Activation	OFF	ON	OFF

ELECTRICAL CONNECTIONS

Electrical connections to the unit are made using the wiring harness supplied. If the unit needs service the connector can be easily removed without unwiring the harness.

The power supply of the unit must be capable of delivering peak currents up to 50 amps for adequate short circuit protection and reliable operation. The preferred source is directly at the vehicle battery. A fuse on the rear of the unit protects from overload.

Disconnect vehicle battery before making any electrical connections.

Extend leads using adequately sized wiring and terminals or splices.

Wire Size and Termination - The diagram shows the minimum wire size used for each connection, along with recommended lead color. If the wire is longer than 10 ft. use the next larger wire size. Use only high quality crimp connectors for installation on the vehicle.

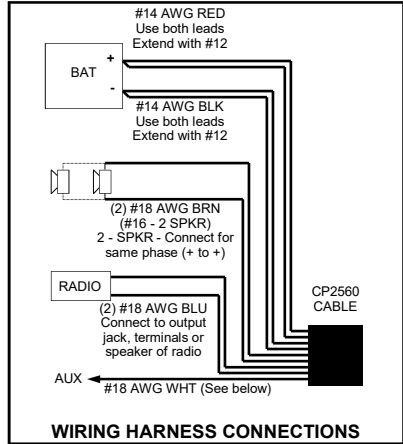

Negative Connection (Black) - Both leads must be used. Connect to the negative battery connector or to chassis ground.

Positive Connection (Red) - Both leads must be used. Connect to the positive battery connector or to a high current power buss. A power relay may be used.

Speaker Connection (Brown) - Both leads must be used. Connect 1 lead to each terminal or lead of the speaker. When used with 2 speakers connect each brown lead to both speaker terminals or leads (parallel circuit). Observe polarity (phasing) when connecting 2 speakers.

Radio Input Connection (Blue) - Connect 1 lead to each terminal of the radio speaker or output connector. The input is isolated and polarity is not important.

Auxiliary Input Connection (White) - The Auxiliary Input allows activation by an external source of the Siren push button function. See OPTION SWITCHES section for further details.

Traditional Auxiliary Input Connection - The auxiliary input is activated with positive (+VDC) AND negative (-VDC). A normally open horn ring circuit or switch is required for proper operation. If a normally open circuit is not used the auxiliary input will constantly be activated. If this is the case, a diode must be placed in series with auxiliary input to block the normally off state. The adjacent diagram shows a horn ring connection example. See OPTION SWITCHES section for further details.

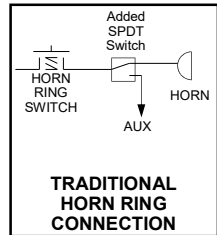

NOTE: Permanent disconnection of the vehicle horn is NOT recommended.

Polarity Selectable Auxiliary Input Connection - The auxiliary input may be activated with positive (+VDC) OR negative (-VDC). The adjacent diagram shows three connection examples.

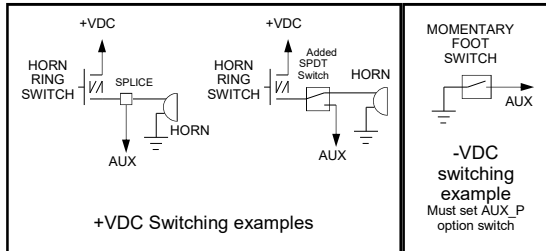

NOTE: Permanent disconnection of the vehicle horn is NOT recommended.

OPERATION

WARNING Sound Hazard - Sound level from siren speaker (>120dBA @ 10 feet) may cause hearing damage. Do not operate siren without adequate hearing protection for yourself and others in immediate vicinity.



GENERAL

This unit is designed for easy operation under the stress associated with high-speed pursuit. Most siren functions are accessible with one simple motion without repetitive activation of switches or automatic timed switching that can interfere with desired operation.

SELECTOR SWITCH

The 6-position rotary selector switch controls the primary operating function of the siren.

Phaser - A very rapidly changing tone used at intersections or in highly congested areas. Can be optionally disabled or replaced with Two-Tone.

Yelp - A rapidly changing tone used in congested areas.

Wail - A slower changing tone used on highways.

Man - Or Manual, the siren tone is controlled manually by the Siren button or auxiliary input.

Horn - A standby mode that allows Horn Override.

Radio - Also known as Radio Repeat, this function amplifies a radio speaker input for re-broadcast outside the vehicle. No siren tones or PA operation are available in this position.

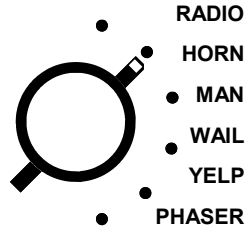

SIREN SWITCH

This momentary push-button switch provides various control functions in conjunction with the Selector Switch. These functions are manual tone control in the Manual position, Horn Override in the Phaser, Yelp and Horn positions, and Power C Toggle Override in the Wail position. It can optionally control Horn Ring Cyclor 2 operation in the Horn position if HRC2 option is selected.



MICROPHONE (PA Override)

The attached noise-canceling microphone is used for public address operation and overrides any siren tone when the button on the side is pressed.

PA VOL

This control adjusts the PA volume. With the vehicle parked, set the PA volume to the maximum level with no feedback (squeal).



AUXILIARY INPUT

During installation an auxiliary input may be connected to the horn ring or other switching device. It provides the same operation as pressing the Siren button.

RADIO VOLUME

The radio repeat volume level is set using an adjustment inside the case just behind the PA volume control. Press on the rear of the case to open the unit, then set the Selector Switch to the Radio position and turn on the power. With the radio volume set to normal level, adjust the siren radio repeat control to the desired level. Turn off power and press the unit back into the case.

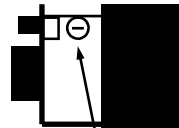

RADIO ADJUST

HORN RING CYCLER 2 (Optional)

During installation, the auxiliary input may be connected to the horn ring or other switching device, and the HRC option selected. With the Selector Switch set to the Horn position, tap the horn ring to bring the unit out of standby into Wail tone. Repeatedly tapping the horn ring will cycle through Wail, Yelp, and Phaser tones. Tapping the horn ring twice quickly will stop the siren tones and return the unit to standby. Pressing and holding the horn ring will produce Horn tone until released. Then the siren will return to its previous siren tone or standby.

NOTE: Earlier units with S/N lower than 04190000 have a different version of HRC. In this case the siren tones cycle through Standby, Wail, Yelp, and Phaser. The tone is stopped by cycling to Standby.

SERVICE

This unit is designed to provide years of reliable service under even the worst conditions. Many times there may appear to be a problem with the unit when the true problem is in the speaker(s) or improper installation. The following chart shows typical symptoms and possible causes.

A blown rear panel fuse doesn't necessarily mean that the unit is bad. If a speaker or speaker lead is shorted this fuse will blow before the unit is damaged. Disconnect the SPKR leads and replace the fuse. If the siren emits a sound when in the Trip position it is OK. Check the speaker (s) or leads for possible shorting.

PROBLEMS

Symptom	Possible Cause	Check
No power or siren output	Power switch not turned on Bad speaker(s) Connector loose Fuse blown Loose connection at power source	Does backlighting come on? Do you hear a "pop" when turned on? With siren on, yelp selected, listen for tone in amplifier. Is an external fuse or circuit breaker used? Are the negative leads connected to a good ground?
No siren tone - PA works	High Voltage Protection Mic button stuck	Input voltage must be less than highest rated voltage. Does mic button release properly?
No PA	PA volume not set properly Selector in Radio position	Have you tried turning the PA volume control? PA is not available in the Radio position
Distorted siren sound	Speaker assembly loose Intermittent Aux Input connection Low vehicle voltage	Is the speaker bell or lip loose? Is the Aux Input used and wired properly? Input voltage must be greater than lowest rated voltage.
Intermittent siren tone	High Voltage Protection Connector loose Bad power connection Mic button activation Circuit breaker in supply connection	Is the vehicle voltage regulator working properly? Is the connector tight on the back of the unit? Is there a loose connection on a power lead? Is something lying on the microphone? Is a circuit breaker used with at least a 50A rating?
Horn function Or Manual stuck on	Siren switch stuck Aux Input improperly connected	Does the Siren switch return fully when released? Is the Aux Input used and wired properly? Aux Input is activated with positive or negative.
No Radio	Unit not connected to radio Radio volume too low	Is the radio connected properly to the unit? Can you here the radio in the vehicle? Have you tried turning the RAD volume control?
Wrong siren tone	Two-Tone option installed	Is the T-T option switch turned on?
Phaser not working	Phaser disabled	Is the P_I option switch turned on?
Horn not working	Horn disabled	Is the H_I option switch turned on?

PARTS

The following parts are available from Carson Manufacturing Company, Inc.:

Part	Description
CP3966	Bolt, mounting, 1/4-20 x 3/8" (2 required)
CP3571	Bracket, mounting
CP4732	Control, 1K Vertical Trimmer
CP3547	Control, 350 Ohm Mini-Pot (PA volume)
ES00026-03	Cover (not including chassis)
ATO/ATC 20A	Fuse, 20 Amp Automotive
CP4852	Knob, Selector Switch
CP4853	Knob, Volume Control
CP4826	Label, Front Panel
ED1680	Lead Asmb, Chassis Plug (internal)
CP2560	Lead Asmb, Standard Siren Cable
CP4750	Microphone, Noise Canceling w/Connector
CP3633	Microphone Bracket with mounting Screws
SR-15-1	Microphone Strain Relief
8025 DRS/CAP	Nut, 1/4-40 Dress w/ Red Switch Cap (for Siren pushbutton)
CP4822	Switch, Momentary Push Button, Right Angle (Siren Pushbutton)
CP3962	Switch, Power Rocker
CP3548	Switch, Rotary 6-Pos. Selector
CP4119	Transistor, output (2 required) (Industry standard TIP36C)
CP5212	Instruction Manual

RETURN

If you have any questions concerning this or any other Carson product, please contact our **Technical Service Department** at (888) 577-6877. Many issues can be handled over the phone. We can also be reached via e-mail at **service@carsonsirens.com**

If a product must be returned for any reason, please contact our Technical Service Department to obtain a Returned Merchandise Authorization number (RMA#) before you ship the product to Carson. Please write the RMA# clearly on the package near the mailing label. Be sure to provide a return address, contact and phone number, along with a brief description of the problem.

LIMITED WARRANTY

Carson Manufacturing Company, Inc. warrants this new product to be free from defects in material and workmanship, under normal use and service, for a period of five (5) years from the date of delivery to the first user-purchaser.

During this warranty period the obligation of Carson Manufacturing is limited to repairing or replacing, as Carson Manufacturing may elect, any part or parts of such product which after examination by Carson Manufacturing is determined to be defective in material and/or workmanship.

This warranty does not cover labor charges for removal or re-installation of the product. Fuses and lamps are not covered under this warranty.

This warranty does not extend to any unit that has been subjected to abuse, misuse, improper installation or which has not been adequately maintained, nor to units which have problems related to service or modification at any facility other than the manufacturer.

THERE ARE NO OTHER WARRANTIES, EXPRESSED OR IMPLIED, INCLUDING BUT NOT LIMITED TO, ANY IMPLIED WARRANTIES OF MERCHANTABILITY OR FITNESS FOR A PARTICULAR PURPOSE. IN NO EVENT SHALL CARSON MANUFACTURING COMPANY, INC. BE LIABLE FOR ANY LOSS OF PROFITS OR ANY INDIRECT OR CONSEQUENTIAL DAMAGES ARISING OUT OF ANY SUCH DEFECT IN MATERIALS OR WORKMANSHIP.